



**CATÁLOGO PISCINAS**  
**POOL CATALOGUE**





- > **Piscinas** PÁG. 06  
Pools
- > **Acessórios** PÁG. 36  
Accessories
- > **Montagem** PÁG. 46  
Installation
- > **Aquecimento e Proteção** PÁG. 52  
Heating and Protection
- > **Wellness** PÁG. 56



# Modelo / Model > Astral

PÁG. 08

LARGURA/WIDTH > 2.46m · COMPRIMENTO/LENGTH > 5.50m · PROFUNDIDADE MÍN./MIN.DEPTH > 1.17m · MÁX./MAX.DEPTH > 1.40m

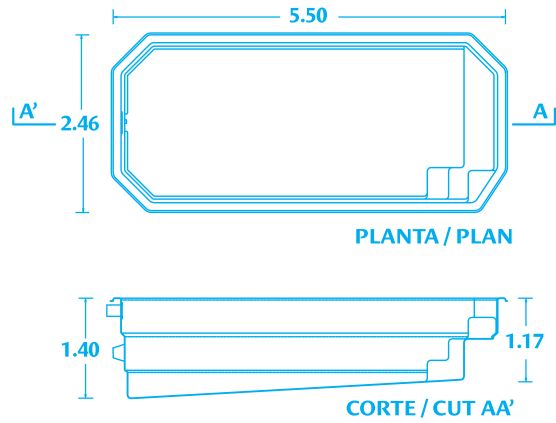

# Modelo / Model > Akiles

PÁG. 10

LARGURA/WIDTH > 3.40m · COMPRIMENTO/LENGTH > 6.80m · PROFUNDIDADE MÍN./MIN.DEPTH > 1.17m · MÁX./MAX.DEPTH > 1.45m

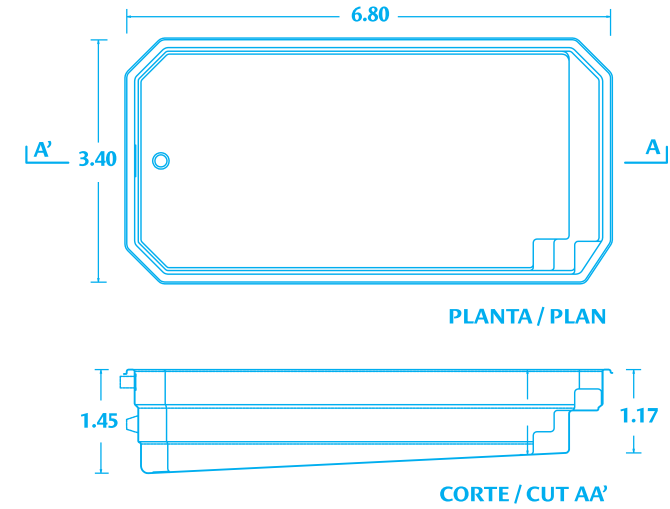

# Modelo / Model > Amazonia

PÁG. 16

LARGURA/WIDTH > 4.20m · COMPRIMENTO/LENGTH > 7.90m · PROFUNDIDADE MÍN./MIN.DEPTH > 1.45m · MÁX./MAX.DEPTH > 1.50m

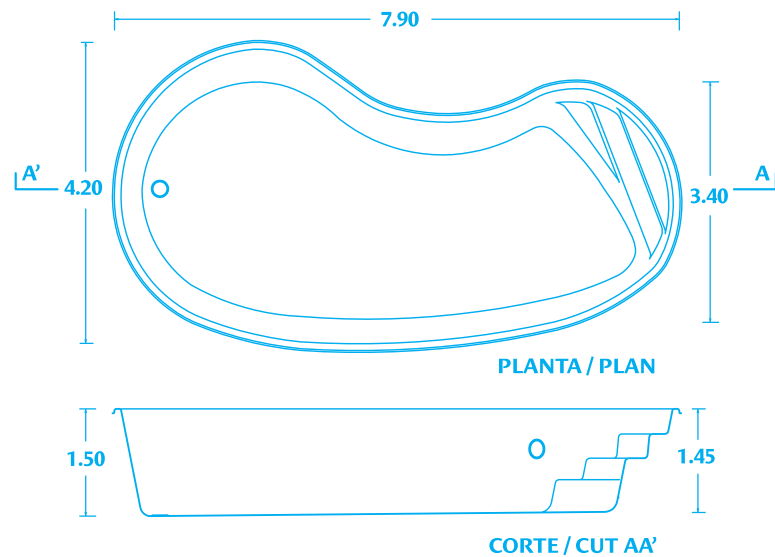

# Modelo / Model > Atlantida

PÁG. 18

LARGURA/WIDTH > 4.10m · COMPRIMENTO/LENGTH > 8.55m · PROFUNDIDADE MÍN./MIN.DEPTH > 1.25m · MÁX./MAX.DEPTH > 1.80m

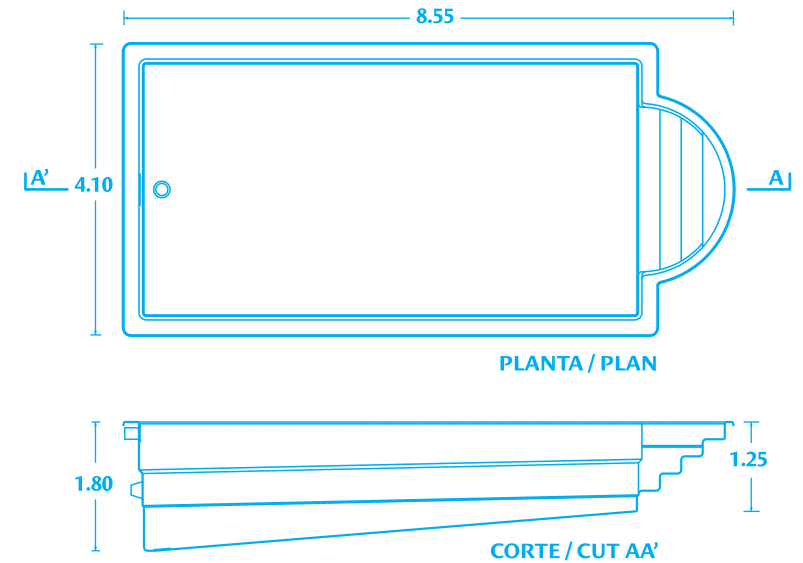

# Modelo / Model > Alfa

PÁG. 12

LARGURA/WIDTH > 3.50m · COMPRIMENTO/LENGTH > 7.50m · PROFUNDIDADE MÍN./MIN.DEPTH > 1.20m · MÁX./MAX. DEPTH > 1.55m

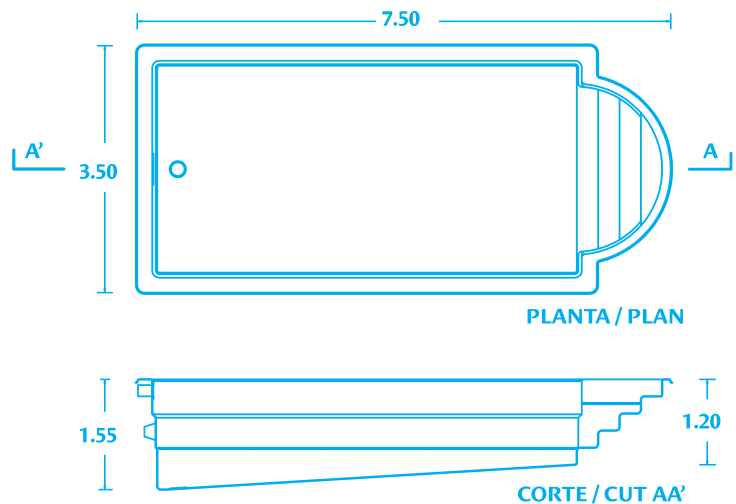

# Modelo / Model > Apolo

PÁG. 14

LARGURA/WIDTH > 4.00m · COMPRIMENTO/LENGTH > 7.90m · PROFUNDIDADE MÍN./MIN.DEPTH > 1.20m · MÁX./MAX. DEPTH > 1.60m

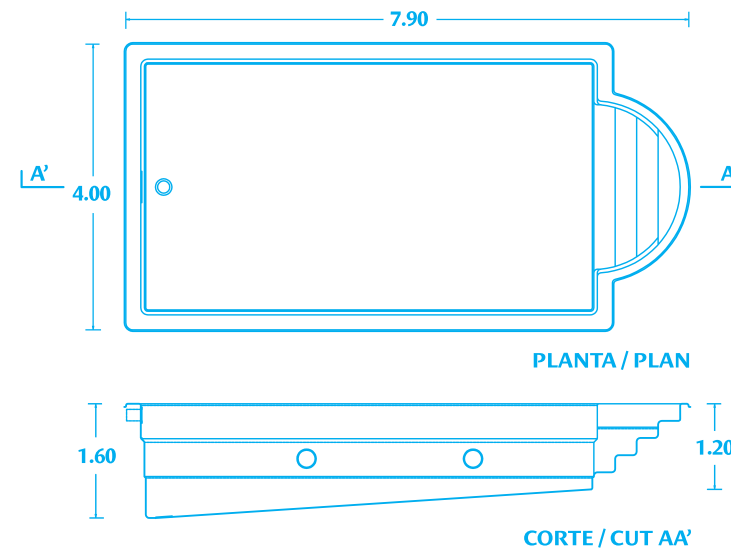

# Modelo / Model > Antarctida

PÁG. 20

LARGURA/WIDTH > 4.35m · COMPRIMENTO/LENGTH > 9.45m · PROFUNDIDADE MÍN./MIN.DEPTH > 1.40m · MÁX./MAX. DEPTH > 1.80m

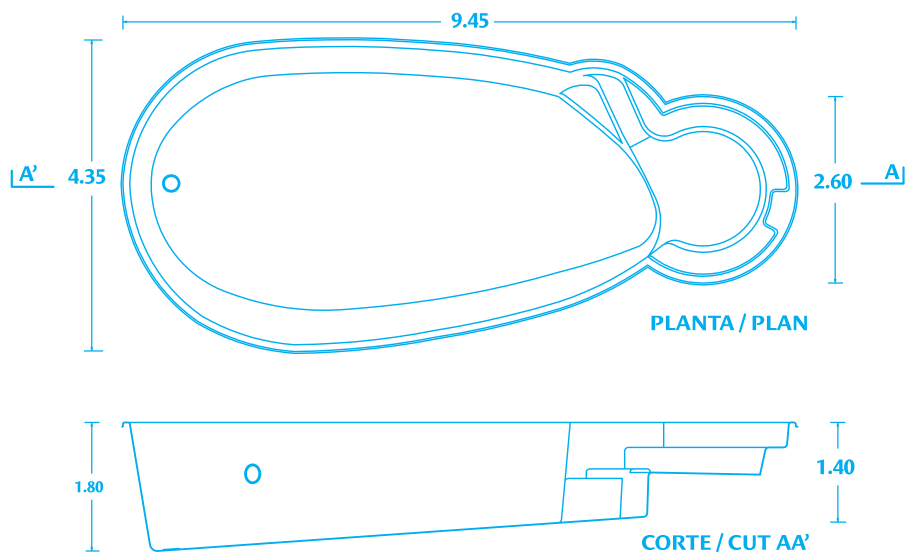

# Modelo / Model > Agurela

PÁG. 22

LARGURA/WIDTH > 4.30m · COMPRIMENTO/LENGTH > 8.80m · PROFUNDIDADE MÍN./MIN.DEPTH > 1.10m · MÁX./MAX. DEPTH > 1.80m

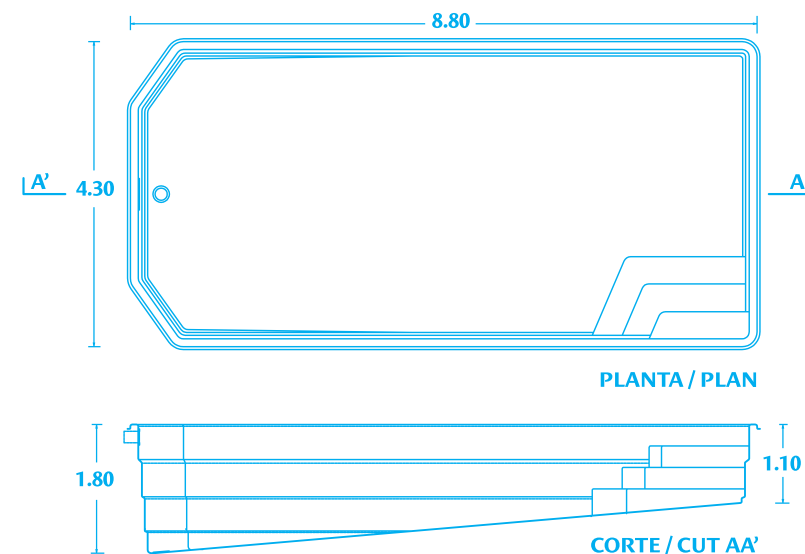

# Modelo / Model > Azteca

PÁG. 24

LARGURA/WIDTH > 4.22m · COMPRIMENTO/LENGTH > 9.22m · PROFUNDIDADE MÍN./MIN.DEPTH > 1.20m · MÁX./MAX. DEPTH > 1.83m

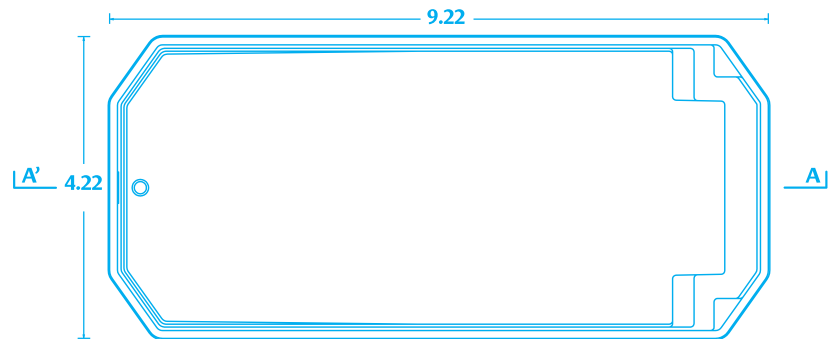

PLANTA / PLAN



CORTE / CUT AA'

# Modelo / Model > Artica

PÁG. 26

LARGURA/WIDTH > 4.00m · COMPRIMENTO/LENGTH > 9.80m · PROFUNDIDADE MÍN./MIN.DEPTH > 1.20m · MÁX./MAX. DEPTH > 1.87m

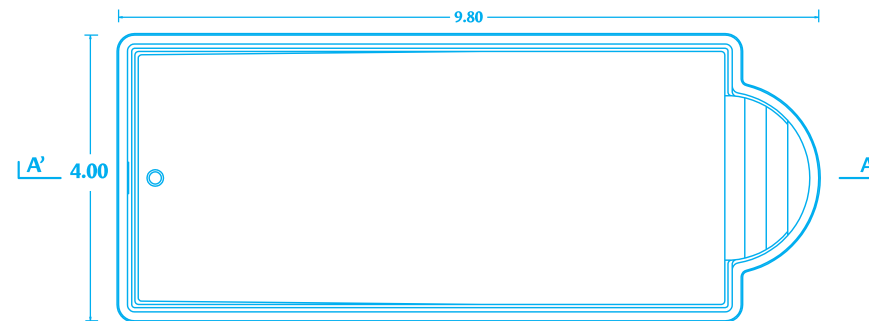

PLANTA / PLAN



CORTE / CUT AA'

# Modelo / Model > Avila

PÁG. 32

LARGURA/WIDTH > 4.25m · COMPRIMENTO/LENGTH > 10.55m · PROFUNDIDADE MÍN./MIN.DEPTH > 1.20m · MÁX./MAX. DEPTH > 1.90m

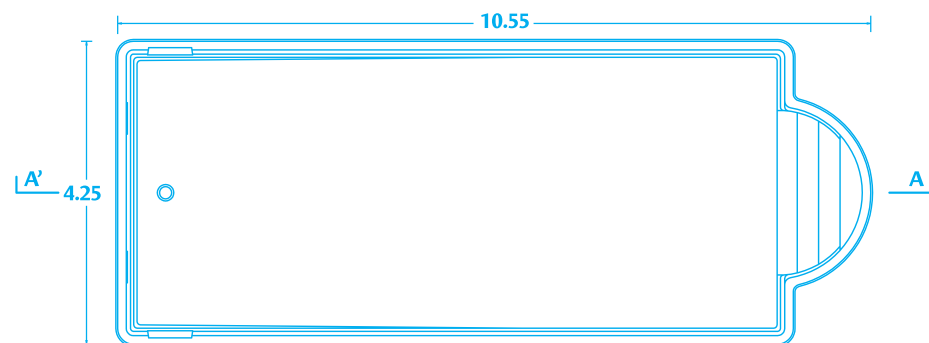

PLANTA / PLAN



CORTE / CUT AA'

# Modelo / Model > Acqualiz

PÁG. 34

LARGURA/WIDTH > 4.65m · COMPRIMENTO/LENGTH > 11.05m · PROFUNDIDADE MÍN./MIN.DEPTH > 1.20m · MÁX./MAX. DEPTH > 1.95m

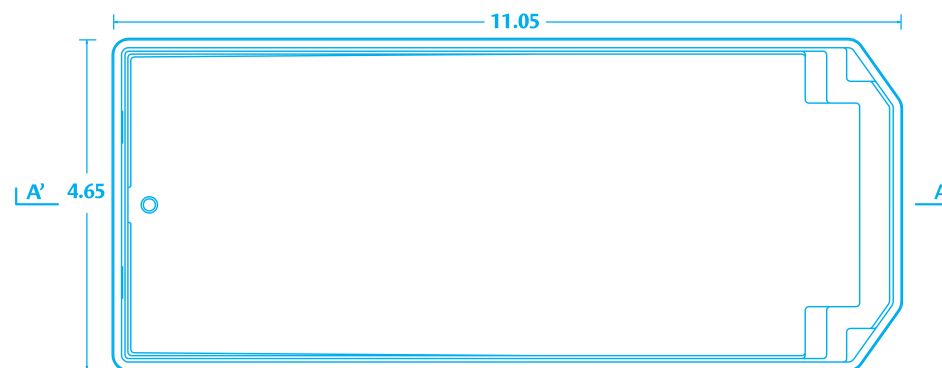

PLANTA / PLAN

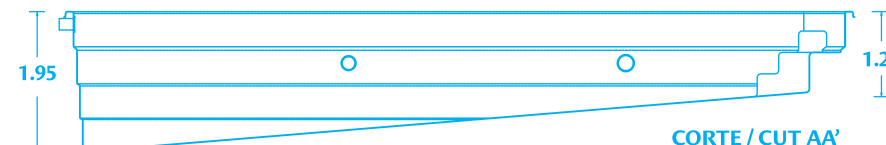

CORTE / CUT AA'

LARGURA/WIDTH > 4.00m · COMPRIMENTO/LENGTH > 10.85m · PROFUNDIDADE MÍN./MIN.DEPTH > 1.20m · MÁX./MAX. DEPTH > 1.95m

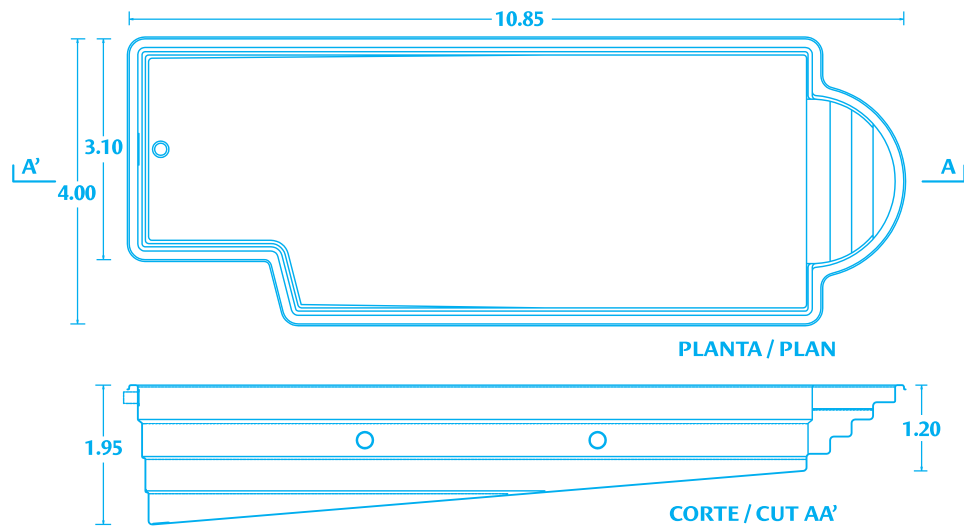

LARGURA/WIDTH > 4.30m · COMPRIMENTO/LENGTH > 10.35m · PROFUNDIDADE MÍN./MIN.DEPTH > 1.10m · MÁX./MAX. DEPTH > 1.95m

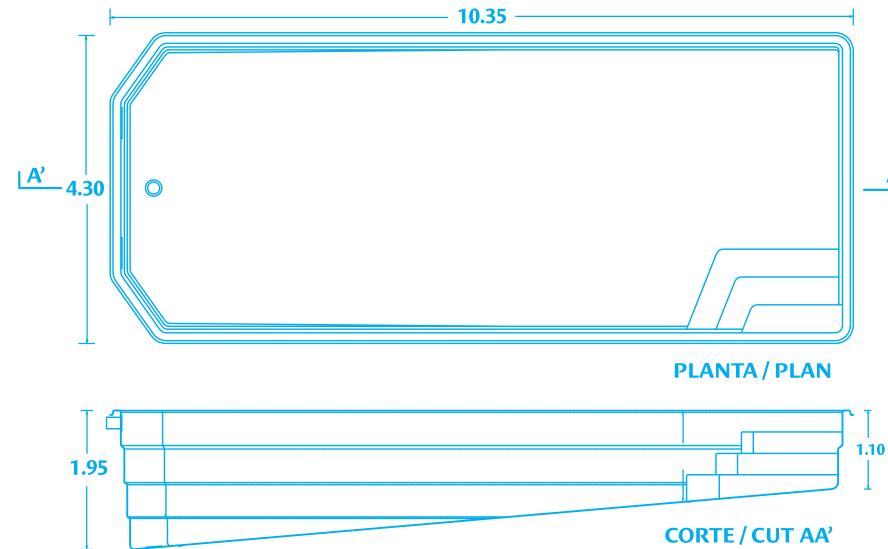



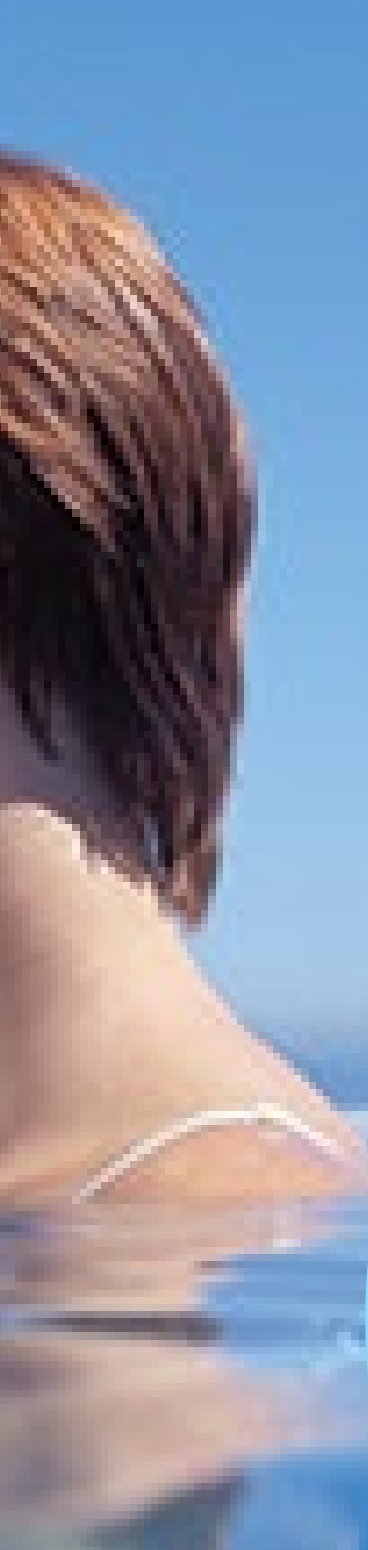

ISO 9001

Empresa em processo  
de certificação pela  
norma ISO 9001



## > Piscinas / Pools

Para fins terapêuticos ou simplesmente para usufruir de momentos relaxantes, a hipótese de mergulhar numa piscina sua há muito que deixou de ser remota. Míme-se a si e aos seus e abrace a magia de ser feliz!

*For therapeutic purposes or simply to enjoy some relaxing moments, the chance of diving in a swimming pool has long ceased to be remote. Indulge yourself and those you love and embrace the magic of being happy!*







LARGURA/WIDTH > 2.46m · COMPRIMENTO/LENGTH > 5.50m · PROFUNDIDADE MÍN./MIN. DEPTH > 1.17m · MÁX./MAX. DEPTH > 1.40m

Versão STD > Injetores com sistema água.  
Versão LUXE > Injetores com sistema ar/água.

STD Version > Injector with water system.  
LUXE Version > Injector with air/water system.

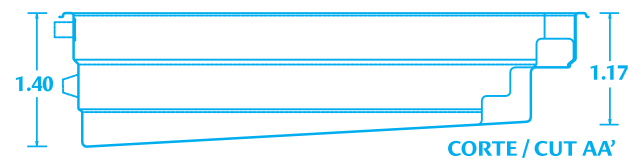
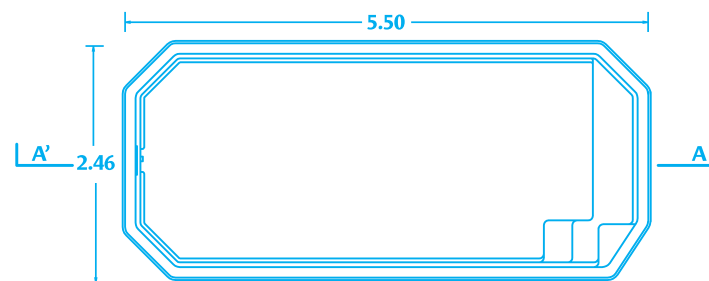

## > Astral

**Concebida com linhas direitas**, ainda que suaves, esta piscina fresca e jovial tem o que é preciso para lhe proporcionar agradáveis momentos de lazer, a sós ou acompanhado, de noite ou de dia, junto à praia ou junto ao campo.

*Designed with straight lines, yet soft, this fresh and youthful pool has what it takes to provide you with pleasant moments of leisure, alone or accompanied, by day or by night, by the beach or in the countryside.*



Modelo / Model > Astral





LARGURA/WIDTH > 3.40m · COMPRIMENTO/LENGTH > 6.80m · PROFUNDIDADE MÍN./MIN.DEPTH > 1.17m · MÁX./MAX. DEPTH > 1.45m

Versão STD > Injetores com sistema água.  
Versão LUXE > Injetores com sistema ar/água.

STD Version > Injector with water system.  
LUXE Version > Injector with air/water system.

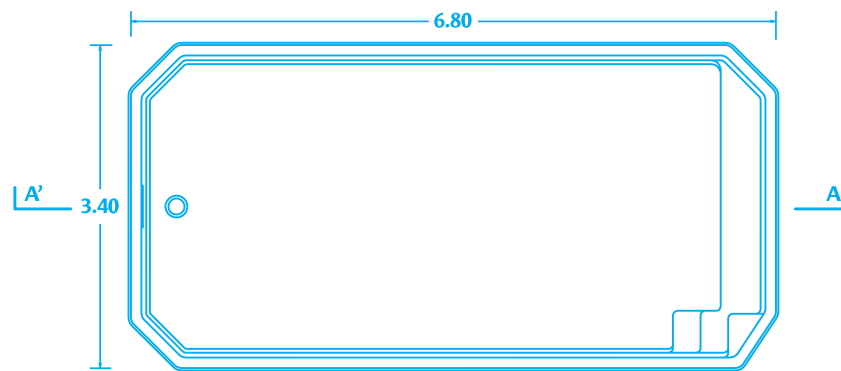

PLANTA / PLAN



CORTE / CUT AA'

## > Akiles

**Família e amigos poderão desfrutar deste modelo na sua plenitude** e viver nele momentos inesquecíveis, apreciando de perto as suas linhas direitas e sofisticadas. Ideal para todo o tipo de ambientes, do mais rústico ao mais moderno. Perfeita para si, que sabe o que quer!

*Family and friends will enjoy this model to the full and live unforgettable moments in it, appreciating its straight sophisticated lines. Ideal for all types of environments, from the more rural to the more modern. Perfect for someone like you, who knows what they want!*

Modelo / Model > Akiles





LARGURA/WIDTH > 3.50m · COMPRIMENTO/LENGTH > 7.50m · PROFUNDIDADE MÍN./MIN.DEPTH > 1.20m · MÁX./MAX. DEPTH > 1.55m

Versão STD > Injetores com sistema água.  
Versão LUXE > Injetores com sistema ar/água.

STD Version > Injector with water system.  
LUXE Version > Injector with air/water system.

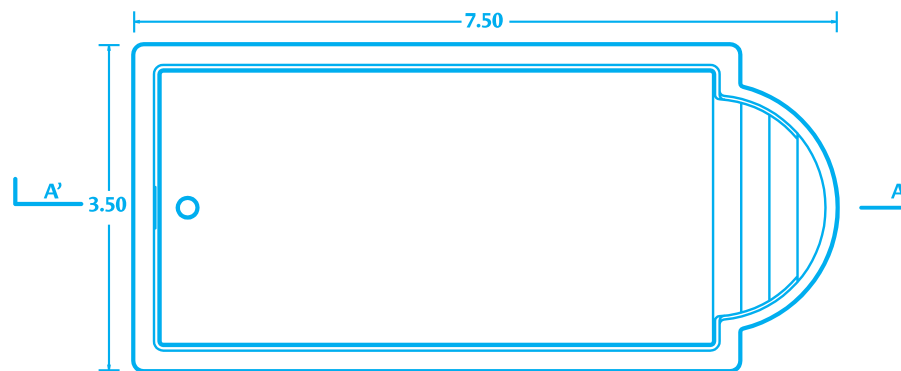

PLANTA / PLAN



CORTE / CUT AA'

## > Alfa

Porque os clássicos serão sempre uma excelente opção, este modelo adapta-se a todo e qualquer estilo de exterior ou interior, surgindo como um elemento de charme pronto a adornar o seu lar e a proporcionar momentos de puro prazer a toda a família.

*Because classics will always be an excellent option, this model adapts to any kind of exterior or interior environment, emerging as an element of charm ready to adorn your home and provide the whole family with moments of pure pleasure.*

Modelo / Model > Alfa





LARGURA/WIDTH > 4.00m · COMPRIMENTO/LENGTH > 7.90m · PROFUNDIDADE MÍN./MIN.DEPTH > 1.20m · MÁX./MAX. DEPTH > 1.60m

Versão STD > Injetores com sistema água.  
Versão LUXE > Injetores com sistema ar/água.

STD Version > Injector with water system.  
LUXE Version > Injector with air/water system.

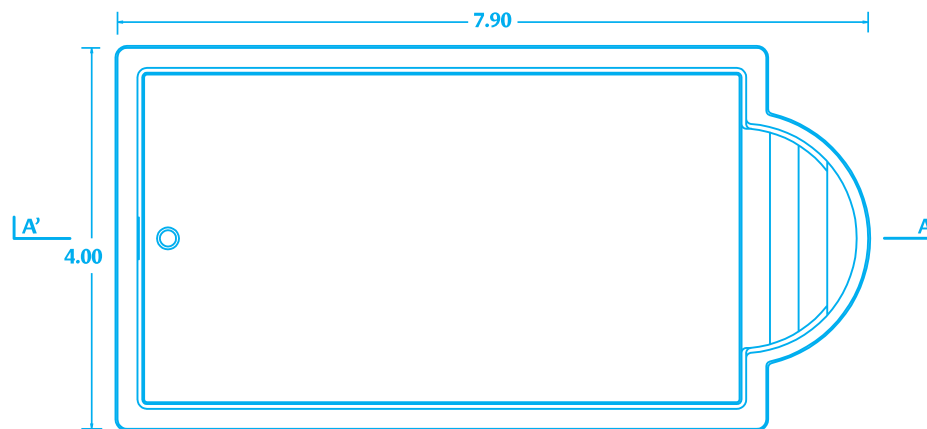

PLANTA / PLAN

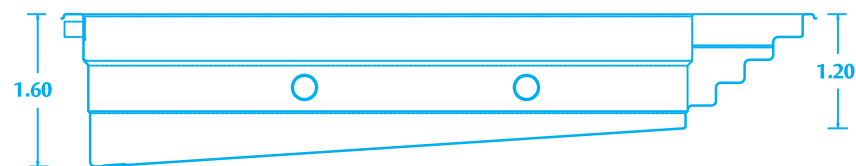

CORTE / CUT AA'

## > Apolo

**Subtileza e requinte** são as palavras que melhor caracterizam este modelo, indicado para abrilhantar uma manhã de sol no campo ou um saboroso fim de dia junto à praia. Dê vida ao seu refúgio!

*Subtlety and refinement are the words that best characterise this model, indicated to brighten a sunny morning in the countryside or a pleasant evening near the beach. Make your retreat come alive!*

Modelo / Model > Apolo







LARGURA/WIDTH > 4.20m · COMPRIMENTO/LENGTH > 7.90m · PROFUNDIDADE MÍN./MIN. DEPTH > 1.45m · MÁX./MAX. DEPTH > 1.50m

Versão STD > Injetores com sistema água.  
Versão LUXE > Injetores com sistema ar/água.

STD Version > Injector with water system.  
LUXE Version > Injector with air/water system.

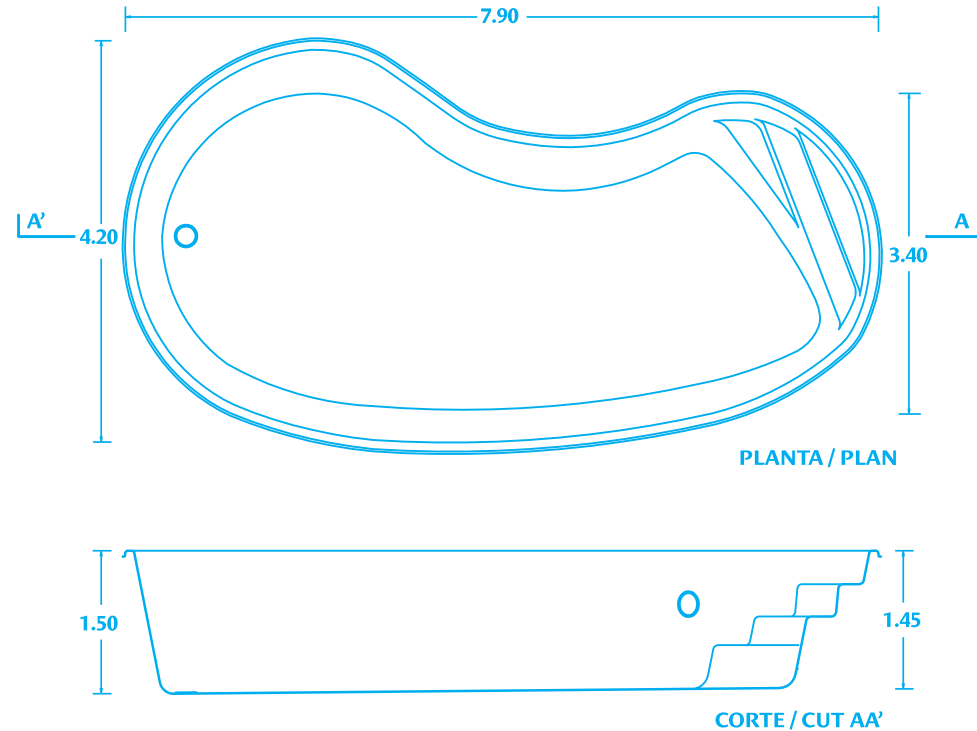

## > Amazonia

**Este modelo único**, de linhas suaves e harmoniosas, promete alegrar o seu jardim e refrescar os seus dias com a singularidade que lhe é característica. Sinta o prazer de um bom mergulho matinal e multiplique-o por todos os dias da sua vida.

*This unique model, with smooth and harmonious lines, promises to brighten your garden and refresh your days with the singularity that characterizes it. Feel the pleasure of a delightful morning swim and multiply it by all days in your life.*

Modelo / Model > Amazonia





LARGURA/WIDTH > 4.10m · COMPRIMENTO/LENGTH > 8.55m · PROFUNDIDADE MÍN./MIN.DEPTH > 1.25m · MÁX./MAX. DEPTH > 1.80m

Versão STD > Injetores com sistema água.  
Versão LUXE > Injetores com sistema ar/água.

STD Version > Injector with water system.  
LUXE Version > Injector with air/water system.

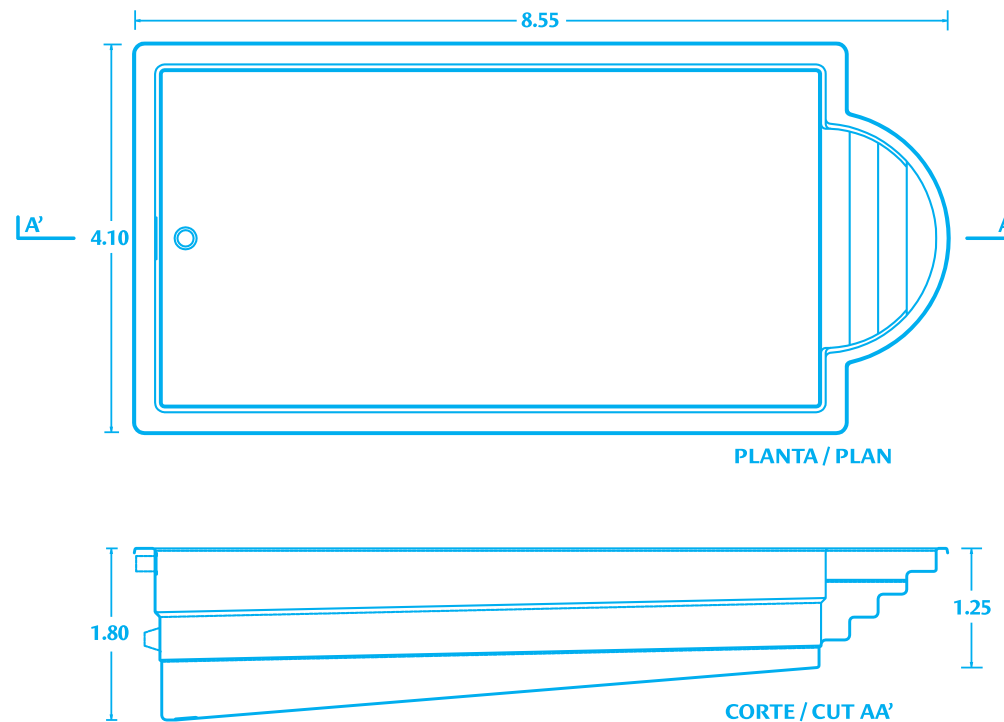

## > Atlantida

**A perfeita sintonia entre o moderno e o tradicional**, aliada às dimensões deste modelo, fazem dele o ideal para espaços amplos. Um belo exemplar em torno do qual poderá abrilhantar os seus dias e as suas noites junto dos que mais ama.

*The perfect harmony between modern and traditional design combined with the dimensions of this model make it ideal for large spaces. A fine example to brighten up your days and nights with those you love most.*

Modelo / Model > Atlantida





LARGURA/WIDTH > 4.35m · COMPRIMENTO/LENGTH > 9.45m · PROFUNDIDADE MÍN./MIN.DEPTH > 1.40m · MÁX./MAX. DEPTH > 1.80m

Versão STD > Injetores com sistema água.  
Versão LUXE > Injetores com sistema ar/água.

STD Version > Injector with water system.  
LUXE Version > Injector with air/water system.

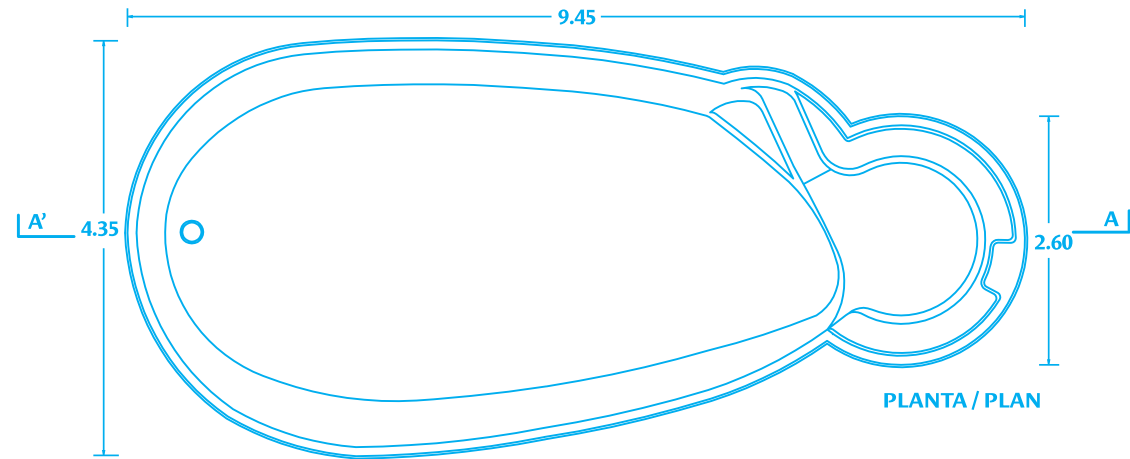

## > Antartida

**Pensada para proporcionar momentos relaxantes e despertar sentidos**, esta piscina original confere a qualquer ambiente um inquestionável toque de alegria e requinte. Um modelo lindíssimo, indicado para si!

*Designed to provide relaxing moments and awaken the senses, this original pool gives any environment an undeniable touch of refinement and joy. A gorgeous model made for you!*

Modelo / Model > Antartida





LARGURA/WIDTH > 4.30m · COMPRIMENTO/LENGTH > 8.80m · PROFUNDIDADE MÍN./MIN. DEPTH > 1.10m · MÁX./MAX. DEPTH > 1.80m

Versão STD > Injetores com sistema água.  
Versão LUXE > Injetores com sistema ar/água.

STD Version > Injector with water system.  
LUXE Version > Injector with air/water system.

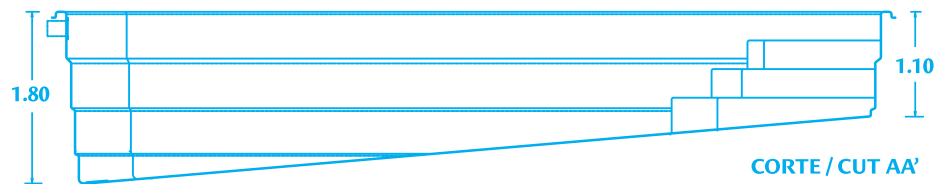
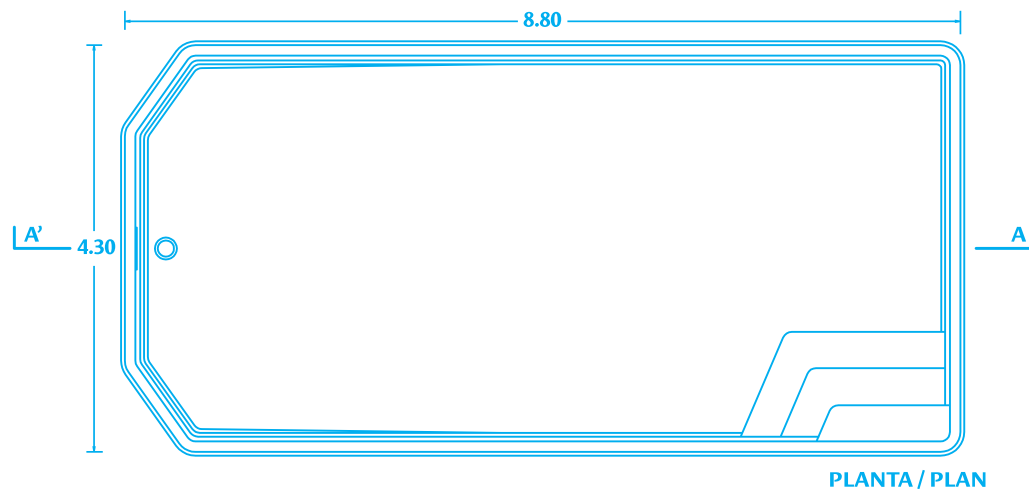

## > Aguarela

**Moderna e imponente**, esta piscina adapta-se na perfeição a todo e qualquer tipo de ambiente, reunindo as condições ideais para agradar a toda a família. Uma excelente opção para quem não abdica de umas boas braçadas.

*Modern and imposing, this pool perfectly adapts to any kind of environment, providing ideal conditions to please the whole family. An excellent choice for those who love a swim.*

Modelo / Model > Agurela







LARGURA/WIDTH > 4.22m · COMPRIMENTO/LENGTH > 9.22m · PROFUNDIDADE MÍN./MIN.DEPTH > 1.20m · MÁX./MAX. DEPTH > 1.83m

Versão STD > Injetores com sistema água.  
Versão LUXE > Injetores com sistema ar/água.

STD Version > Injector with water system.  
LUXE Version > Injector with air/water system.

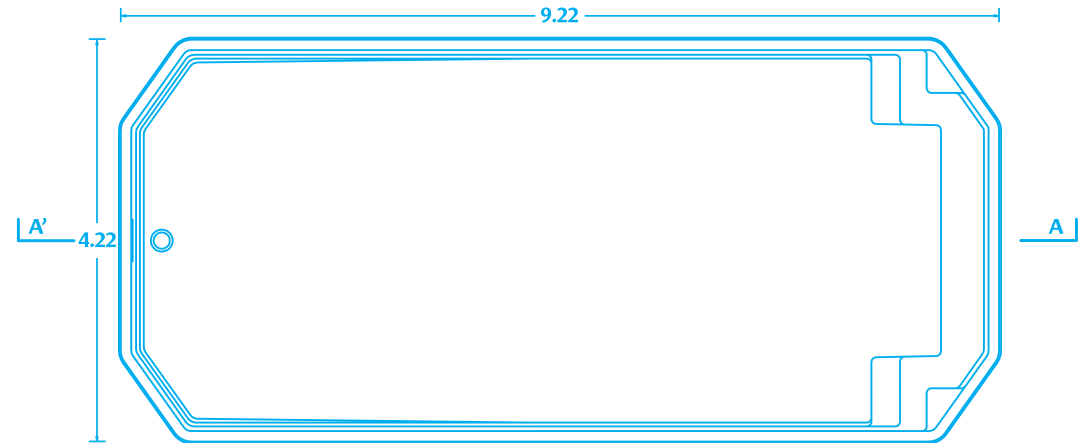

PLANTA / PLAN

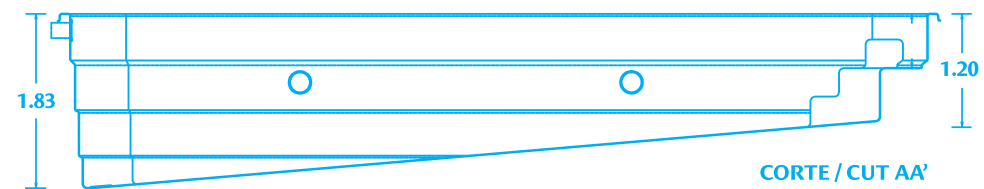

CORTE / CUT AA'

## > Azteca

O estilo clássico deste modelo confere charme a qualquer espaço, alegrando os dias e requintando as noites de quem dele usufrui. Uma piscina elegante, pronta para ajudar a registar muitos momentos plenos.

*The classic style of this model charms any atmosphere, brightening up the days and enriching the nights of those who enjoy it. An elegant pool, ready to help you remember many happy moments.*



Modelo / *Model* > Azteca





LARGURA/WIDTH > 4.00m · COMPRIMENTO/LENGTH > 9.80m · PROFUNDIDADE MÍN./MIN.DEPTH > 1.20m · MÁX./MAX. DEPTH > 1.87m

Versão STD > Injetores com sistema água.  
Versão LUXE > Injetores com sistema ar/água.

STD Version > Injector with water system.  
LUXE Version > Injector with air/water system.

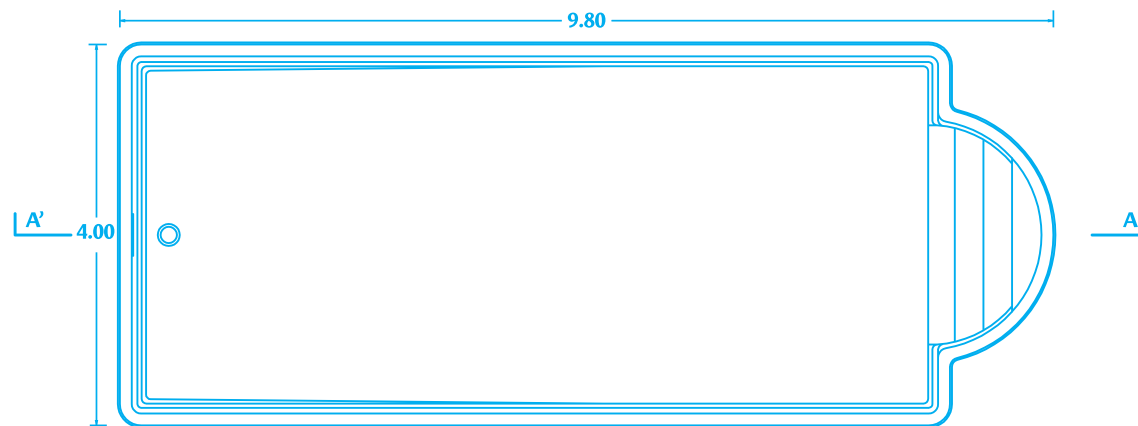

PLANTA / PLAN

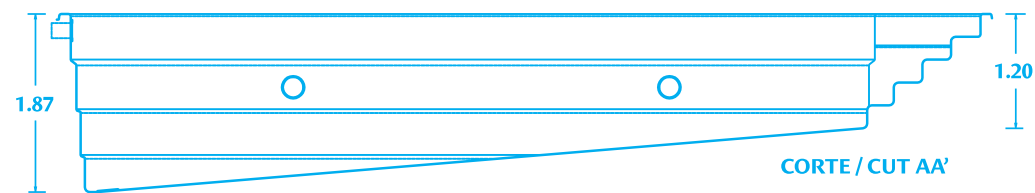

## > Artica

**Moderno e charmoso**, este modelo enquadra-se perfeitamente em qualquer tipo de ambiente e promete acolher e encantar família e amigos por muitos e bons anos, espelhando o azul do céu nas mais limpas e serenas águas.

*Modern and charming*, this model fits perfectly into any environment and promises to welcome and delight both family and friends for many years to come, mirroring the blue sky in its cleanest and most peaceful waters.

Modelo / Model > Artica



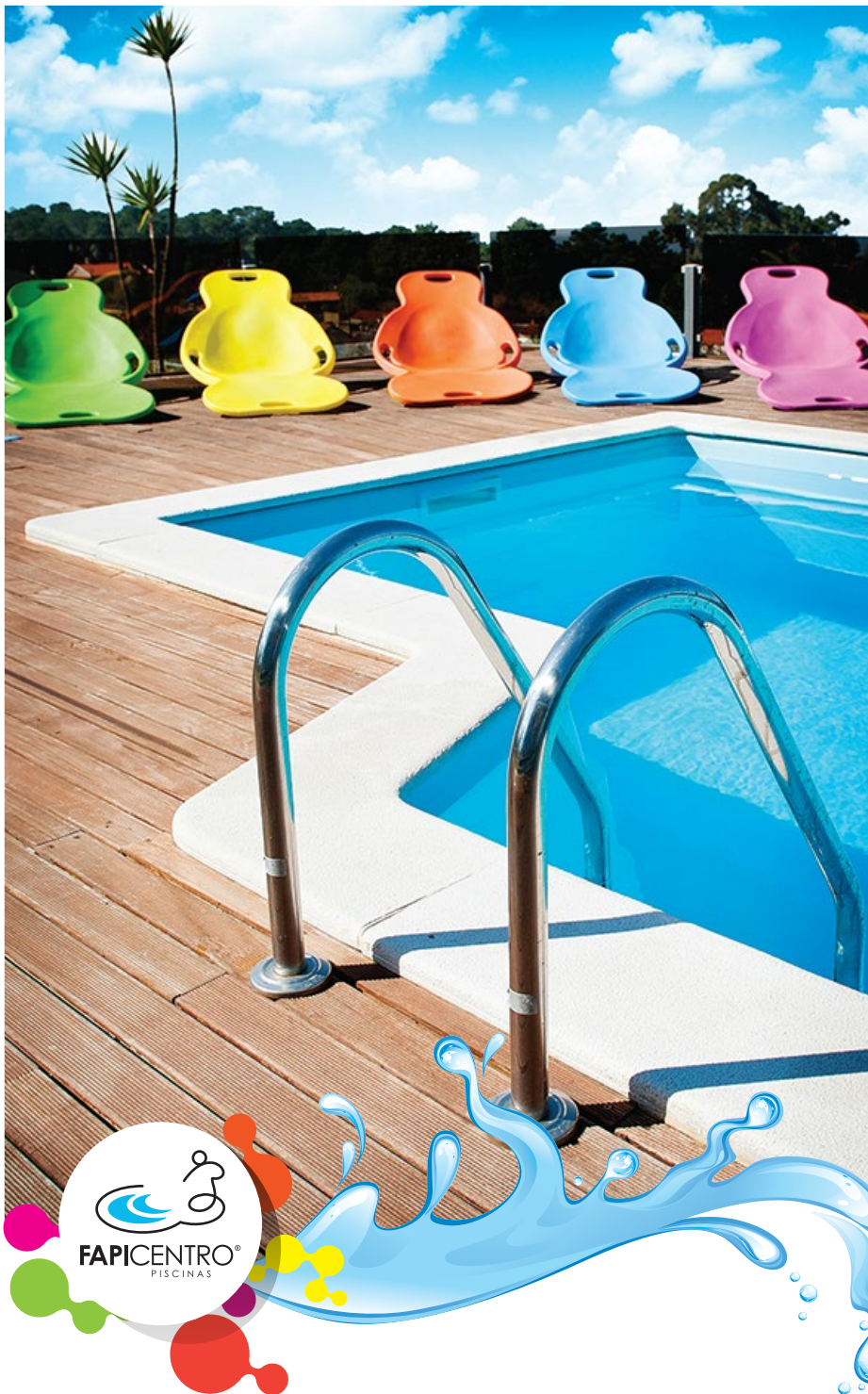

LARGURA/WIDTH > 4.00m · COMPRIMENTO/LENGTH > 10.85m · PROFUNDIDADE MÍN./MIN. DEPTH > 1.20m · MÁX./MAX. DEPTH > 1.95m

Versão STD > Injetores com sistema água.  
Versão LUXE > Injetores com sistema ar/água.

STD Version > Injector with water system.  
LUXE Version > Injector with air/water system.

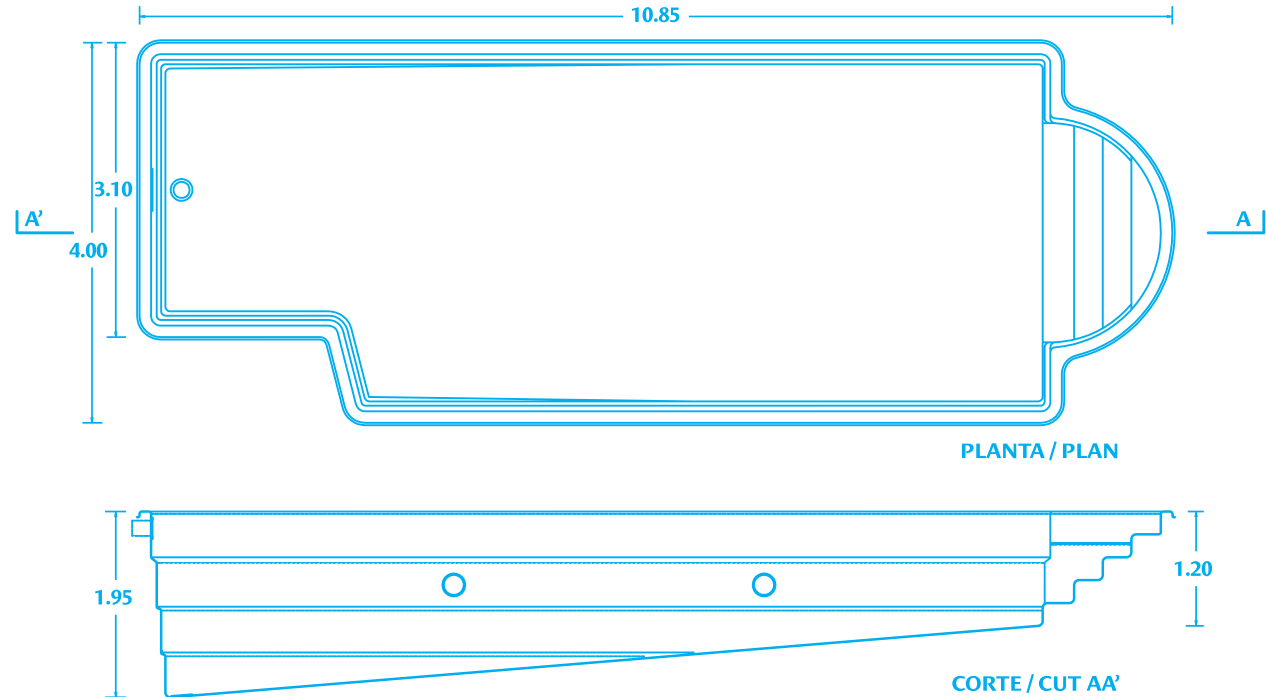

## > Aquarius

**Porque cada espaço é um espaço único**, este modelo foi concebido com um recanto especial e personalizado que contrasta com as linhas tradicionais e que lhe permite uma adaptação paisagística perfeita. O charme e o requinte que faltavam para iluminar as suas tardes de verão!

*Because each space is unique, this model was designed with a special and customized nook, which contrasts with traditional lines and allows it to perfectly adapt to the landscape. The charm and elegance you needed to illuminate your summer afternoons!*

Modelo / Model > Aquarius





LARGURA/WIDTH > 4.30m · COMPRIMENTO/LENGTH > 10.35m · PROFUNDIDADE MÍN./MIN. DEPTH > 1.10m · MÁX./MAX. DEPTH > 1.95m

Versão STD > Injetores com sistema água.  
 Versão LUXE > Injetores com sistema ar/água.

STD Version > Injector with water system.  
 LUXE Version > Injector with air/water system.

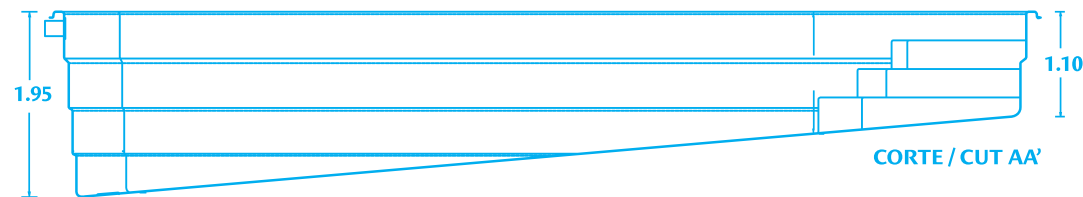
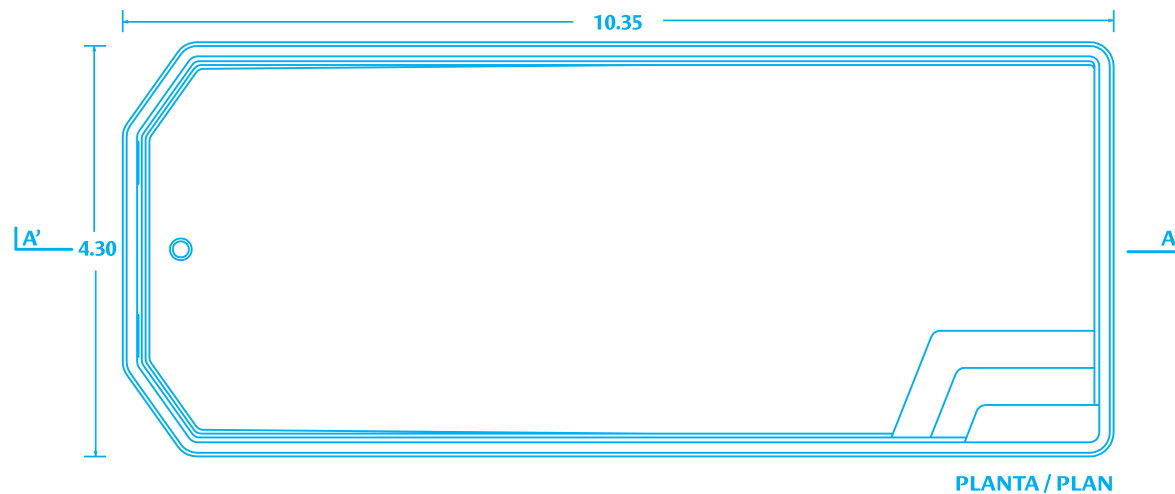

## > Adriatica

**As linhas direitas fazem deste modelo o ideal para qualquer espaço.** Família e amigos poderão desfrutar desta piscina na sua plenitude e viver momentos de puro prazer com toda a alegria e vitalidade.

*Straight lines make this model ideal for any space. Family and friends will enjoy the pool to the full and live moments of pure happiness with joyful satisfaction.*



Modelo / Model > Adriatica







LARGURA/WIDTH > 4.25m · COMPRIMENTO/LENGTH > 10.55m · PROFUNDIDADE MÍN./MIN. DEPTH > 1.20m · MÁX./MAX. DEPTH > 1.90m

Versão STD > Injetores com sistema água.  
 Versão LUXE > Injetores com sistema ar/água.

STD Version > Injector with water system.  
 LUXE Version > Injector with air/water system.

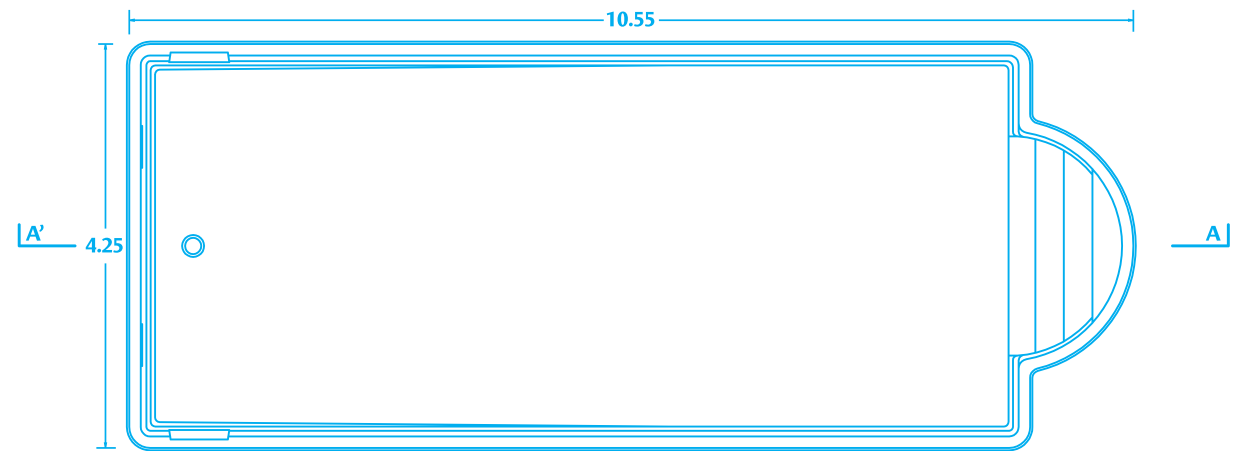

PLANTA / PLAN

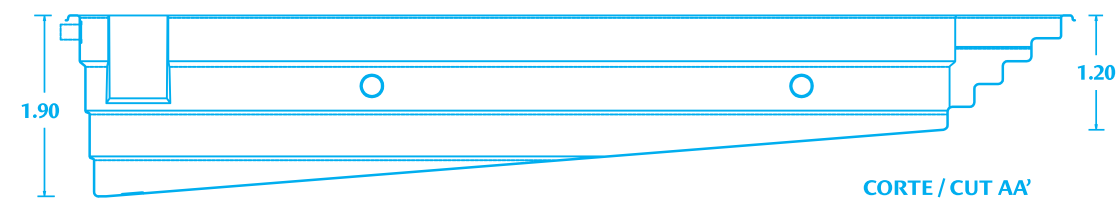

CORTE / CUT AA'

### > Avila

**Porque os clássicos serão sempre uma boa opção**, este modelo adapta-se na perfeição aos mais variados estilos. Para quem vive o presente como se não houvesse amanhã, eis um belo convite a deliciosos momentos em família ou a dois numa fresca noite de inverno ou numa doce tarde de verão.

*Because classics will always be a good option, this model fits perfectly into the most varied styles. For those who live the present as if there is no tomorrow, here's a nice invitation to spend some delightful moments with the family or your partner on a cool winter night or a sweet summer evening.*

Modelo / Model > Avila





LARGURA/WIDTH > 4.65m · COMPRIMENTO/LENGTH > 11.05m · PROFUNDIDADE MÍN./MIN.DEPTH > 1.20m · MÁX./MAX.DEPTH > 1.95m

Versão STD > Injetores com sistema água.  
Versão LUXE > Injetores com sistema ar/água.

STD Version > Injector with water system.  
LUXE Version > Injector with air/water system.

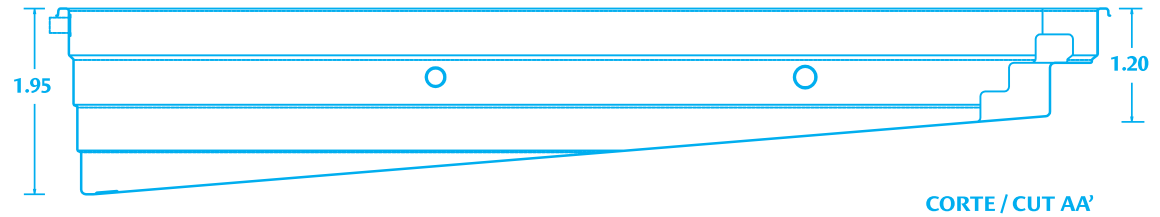
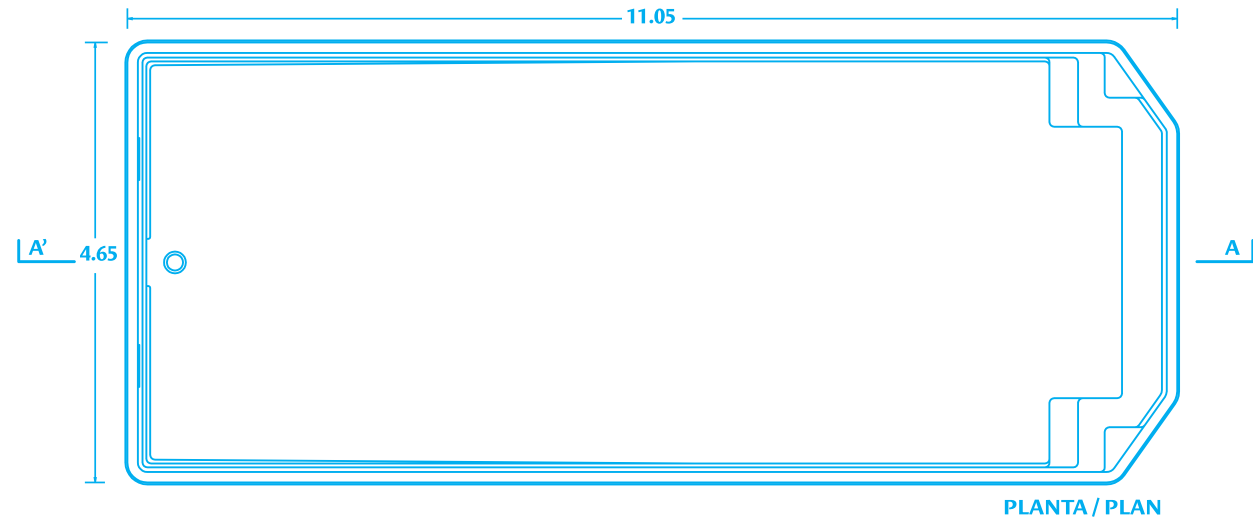

## > Acqualiz

**De design moderno e fresco**, esta piscina adapta-se na perfeição a todo e qualquer tipo de ambiente, conferindo-lhe o seu aspeto e a sua inquestionável qualidade as condições ideais para agradar a toda a família. Um mimo para si e para os seus!

*Fresh and modern, this pool adapts perfectly to any type of environment with its aspect and unbeatable quality, ideal to suit the whole family. A treat for you and the ones you love!*

Modelo / Model > Acqualiz







## > Acessórios / Accessories

Entre espreguiçadeiras, cadeiras e escorregas, muitos são os acessórios a que família e amigos poderão recorrer num dia de sol ou numa noite quente de verão. Porque o descanso e a qualidade também podem andar de mãos dadas, temos os complementos certos para si.

*Loungers, chairs and slides are some of the many accessories family and friends may use on a sunny day or a warm summer evening. Because rest and quality can also go hand in hand, we have the right accessories for you.*





LARGURA / LENGTH > 0.52m · COMPRIMENTO / WIDTH > 1.70m · ALTURA / HEIGHT > 0.72m

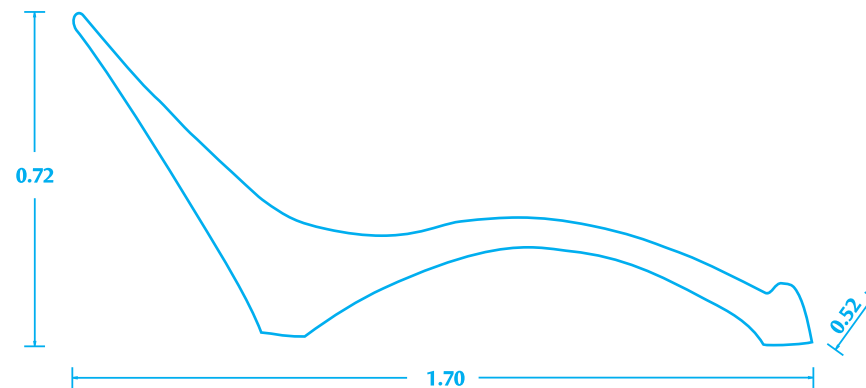

### > Espreguiçadeira

**Sozinho ou acompanhado**, a ler ou a conversar, nada como uma boa espreguiçadeira para os momentos mais relaxantes. Modernas e confortáveis, as nossas espreguiçadeiras estão à altura do desafio.

### > Lounger

*Alone or accompanied, reading or chatting, nothing like a good lounger for the most relaxing moments. Modern and comfortable, our loungers are up to the challenge.*

Modelo / Model > Espreguiçadeira / Lounger







ALTURA / HEIGHT > 1.80m · COMPRIMENTO DA BASE / BASIS LENGTH > 2.81m

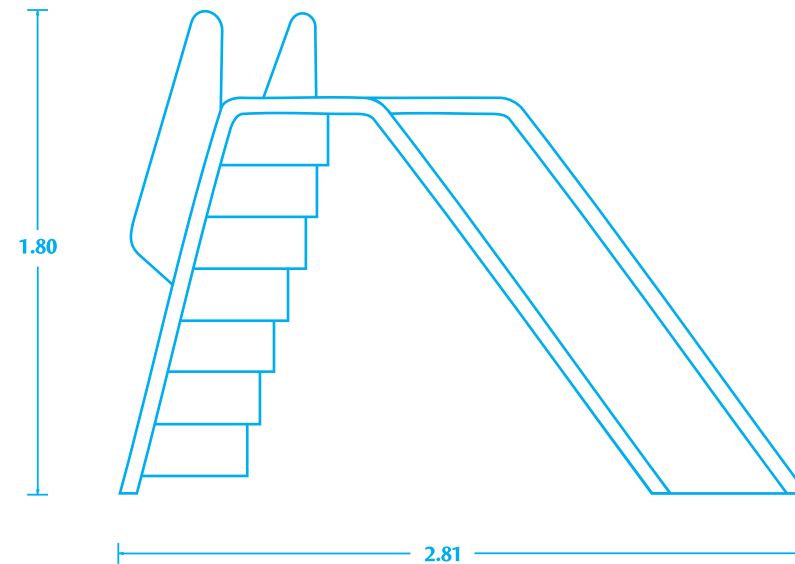

### > Escorrega

**Atreva-se a colorir os seus dias**, acrescentando alegria aos espaços de lazer. Um bom escorrega é sempre sinónimo de festa. Os mais novos ficar-lhe-ão gratos!

### > Slide

*Dare to brighten up your days by enjoying your leisure time to the full. A good slide always means a party. Kids will be grateful!*



Modelo / Model > Escorrega / Slide





## Modelo / Model > Banco Duplex *Duplex Bench*

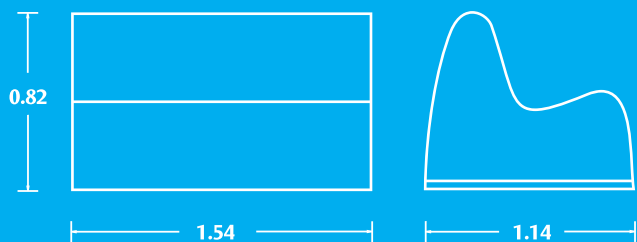

LARGURA / WIDTH > 1.14m  
 COMPRIMENTO / LENGTH > 1.54m  
 ALTURA / HEIGHT > 0.82m

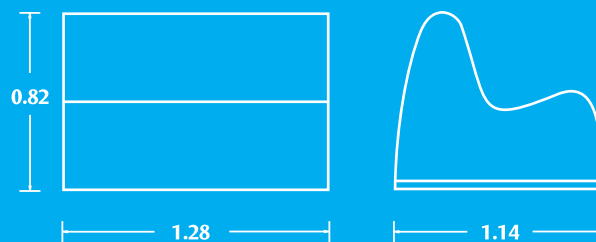

LARGURA / WIDTH > 1.14m  
 COMPRIMENTO / LENGTH > 1.28m  
 ALTURA / HEIGHT > 0.82m

**Mais do que um confortável banco,** o duplex é uma solução elegante e funcional para proteger todo o equipamento de manutenção, de qualquer modelo de piscina.

*More than a comfortable seat, the duplex is an elegant and functional solution to protect all maintenance equipment of any kind of pool.*



## Modelo / Model > Hidromassagem *Hydromassage*

### > Modelo / Model Hidroplus

LARGURA / WIDTH ( DIÂMETERO / DIAMETER ) > 2.65m  
PROFUNDIDADE / DEPTH > 0.73m

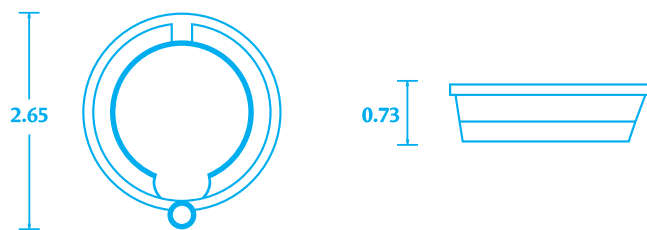

### > Modelo / Model Hidro

LARGURA / WIDTH ( DIÂMETERO / DIAMETER ) > 2.65m  
PROFUNDIDADE / DEPTH > 0.73m

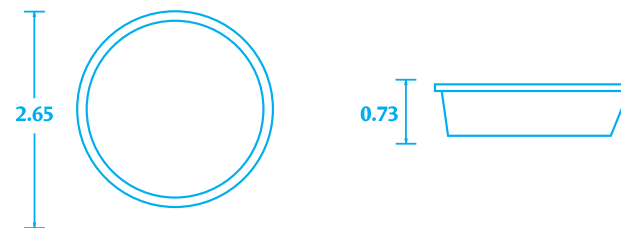



Modelo / Model > Spa Hidromassagem *Hydromassage Spa*



Modelo / Model > Base Chuveiro *Shower Base*

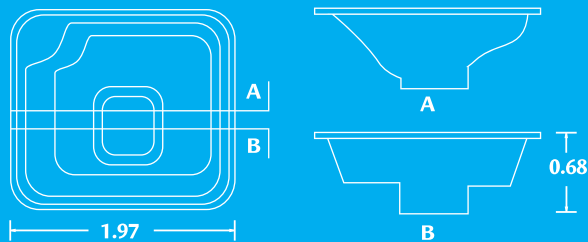

LARGURA / WIDTH > 1.67m  
 COMPRIMENTO / LENGTH > 1.97m  
 PROFUNDIDADE / DEPTH > 0.68m

**Extremamente fácil de usar,** esta piscina de hidromassagem, está preparada para 3 pessoas, uma deitada e duas sentadas.

*Extremely easy to use, this spa pool is ready to be used by 3 people, one of them lying down and the other two sitting.*

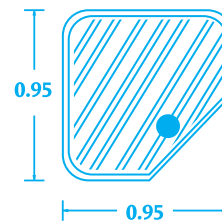

DIMENSÕES / DIMENSIONS > 0.95m X 0.95m  
 PROFUNDIDADE / DEPTH > 0.03m



Modelo / Model > Base Chuveiro *Shower Base*

Modelo / Model > Base Chuveiro *Shower Base*

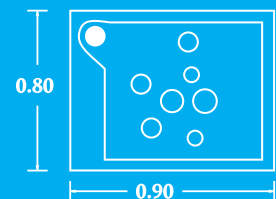

DIMENSÕES / DIMENSIONS > 0.80m X 0.90m  
PROFUNDIDADE / DEPTH > 0.02m

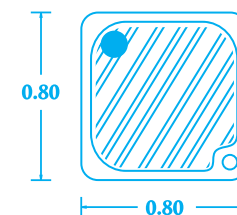

DIMENSÕES / DIMENSIONS > 0.80m X 0.80m  
PROFUNDIDADE / DEPTH > 0.11m





## > Wellness

Estamos atualmente a desenvolver o nosso novo segmento Wellness, projeto que culminará este ano na formalização de parcerias estratégicas com as mais conceituadas marcas do setor, aumentando assim o leque de ofertas de produtos como spas, Jacuzzi, saunas e banhos a vapor. Se procura equilíbrio e bem-estar, nós temos a solução!

*We are currently developing our new Wellness segment, a project that will end this year when we enter strategic partnerships with the most prestigious brands in the sector and increase the range of product offers, such as spas, Jacuzzi, saunas and steam baths. If you are looking for balance and wellbeing, we have the solution!*





## > Wellness

**O Conceito Wellness é a integração total do corpo, mente e espírito – o reconhecimento de que tudo o que a pessoa faz, pensa, sente e acredita tem um impacto no seu estado de saúde e na saúde do mundo.**

Há séculos que o Homem tem vindo a associar, muito sabiamente, os benefícios da água ao seu bem-estar físico, mental e espiritual e foram várias as civilizações que emprestaram sabedoria e popularidade à prática milenar do Spa, a própria palavra spa, expressão latina "sanus per aqua" que significa "saúde através da água" e todo o conceito a ela inerente remete-nos a essas civilizações.

A Fapicentro, no seu segmento Wellness, dispõe de uma vasta gama de produtos como spas, saunas, banhos a vapor e jogos de hidroterapia e duches termais, bem como de um Gabinete de apoio ao Projeto onde poderá criar um Projeto de acordo com as suas necessidades.

Faça uma viagem pelos sentidos, revitalize o seu corpo, desperte a sua mente esqueça o mundo exterior para depois enfrentá-lo de forma positiva.

*The Wellness Concept is the full combination of body, mind and spirit - recognition that everything a person does, thinks, feels and believes in has an impact on their health and on that of the world.*

*For centuries, Man has cleverly associated the benefits of water to his physical, mental and spiritual wellbeing and many civilisations lent wisdom and popularity to the ancient practice of Spa. The very word spa from the Latin "sanus per aqua" meaning "health through water" and the whole related concept lead us to these civilisations.*

*Fapicentro, in its Wellness segment, offers a wide range of products such as spas, saunas, steam baths, hydrotherapy games and thermal showers as well as a support office where you can create a project according to your specific needs.*

*Take a trip through your senses, revitalize your body, awaken your mind and forget the outside world so that you can face it in a positive way afterwards.*









## > Aquecimento e Proteção *Heating and Protection*

Para garantir um ambiente realmente agradável na piscina dos seus sonhos, temos para si vários tipos de coberturas e sistemas de aquecimento cuja principal finalidade é a de lhe oferecer a maior tranquilidade e segurança, protegendo a sua piscina e proporcionando-lhe um ambiente agradável e quente.

*To ensure a truly enjoyable environment in the pool of your dreams, we offer several types of roofs and heating systems whose main purpose is to offer relaxation and security, protecting your pool and providing you with a pleasant and warm atmosphere.*



## >Aquecimento e Proteção *Heating and Protection*

**Oferecemos soluções de aquecimento e de proteção para que possa usufruir da sua piscina todo o ano.**

- Bombas de Calor para Aquecimento.
- Coberturas Telescópicas.
- Coberturas Automáticas.
- Coberturas de Proteção.
- Coberturas Isotérmicas.
- Barreiras de Proteção

*We offer heating and protection solutions so that you can enjoy your pool all year round.*

- *Heat Pumps for Heating.*
- *Telescopic Covers.*
- *Automatic Covers.*
- *Protection Covers.*
- *Isothermal Covers.*
- *Protection Barriers*

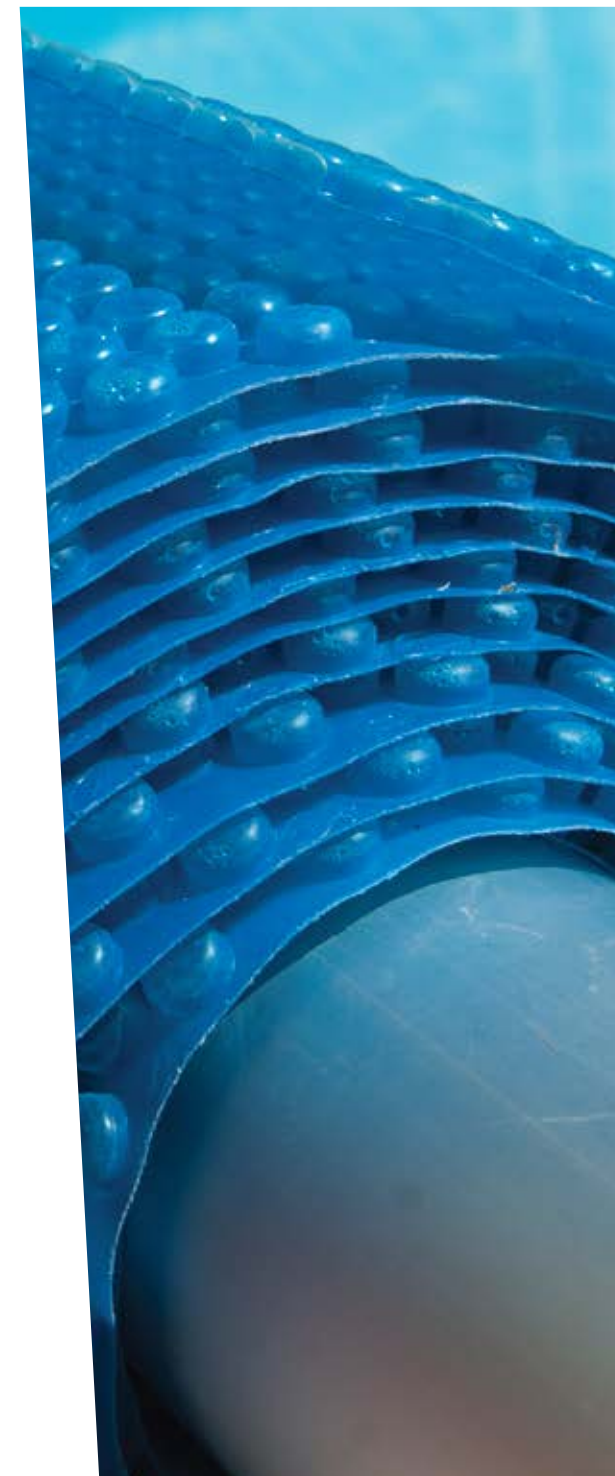







## > Montagem / *Installation*

Em apenas uma semana, os nossos técnicos especializados montam a sua piscina com o devido rigor técnico e o maior profissionalismo. É dessa forma que garantimos a qualidade, já que a sua confiança é o nosso maior bem.

*In just one week, our expert technicians install your pool with absolute rigour and professionalism. This is how we guarantee quality, since your trust is our greatest asset.*





## > Montagem *Installation*

O Processo de instalação das nossas piscinas decorre num prazo total de 1 semana, sendo 3 dias úteis para a aplicação e montagem de toda a estrutura e o restante tempo para operações de teste e arranque de mecanismos.

\* ver especificações técnicas nas pág. 50 e 51

*The pool installation process takes a whole week, 3 days for the application and installation of the entire structure and the remainder to test start-up of operations and mechanisms.*

*\* see technical features on pages 50 and 51*





## > Esp. Técnicas *Technical Features*

**A Fapicentro utiliza a mais moderna tecnologia na fabricação de piscinas em fibra de vidro monobloco, com o objetivo de produzir para si "Qualidade".**

Construídas segundo avançados padrões de qualidade, as piscinas Fapicentro são a solução ideal para o prolongamento do espaço habitacional da sua residência.

**Dispomos de uma assistência técnica permanente, uma linha completa de acessórios e toda a orientação técnica para adequar o modelo certo ao seu espaço.**

Todo o processo produtivo e de instalação é rigorosamente controlado por pessoal qualificado. A resistência das nossas piscinas é o resultado de longos anos de estudo e experiências com estruturas de reforço.

*Fapicentro uses the latest technology in manufacturing fiberglass monobloc pools, aimed at producing "Quality" for you.*

*Built according to advanced quality standards, Fapicentro's pools are the ideal solution for extending your home's living area.*

*We offer permanent technical assistance, a full line of accessories and technical guidance for your model to suit your space.*

*The entire production and installation process is strictly controlled by skilled personnel. Our pools' resistance is the result of several years of study and experience with reinforcing structures.*

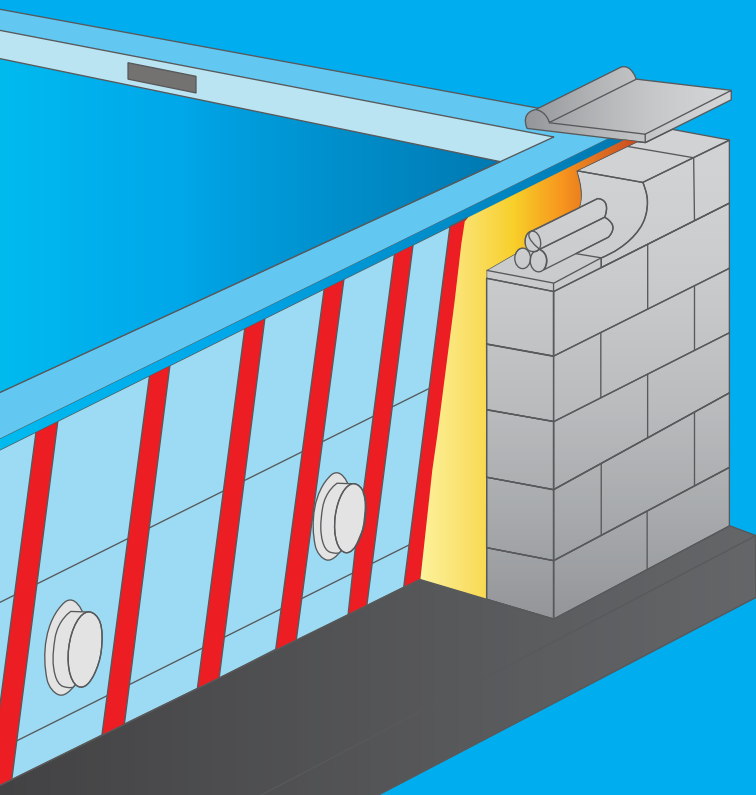

**Corte representativo das forças exercidas quer pela água, quer pela terra contra as paredes das piscinas, onde são colocados diversos reforços em PVC e fibra.**

*Considerable cut in the force of the water or the earth against the walls of the pools, where various PVC and fibre reinforcements are placed.*

**Em todas as piscinas, as paredes têm uma ligeira inclinação que proporciona uma compensação de forças no sentido não só de dentro para fora como também de cima para baixo.**

*In all pools, walls have a slight inclination, which compensates forces not only from inside to outside, but also from top to bottom.*

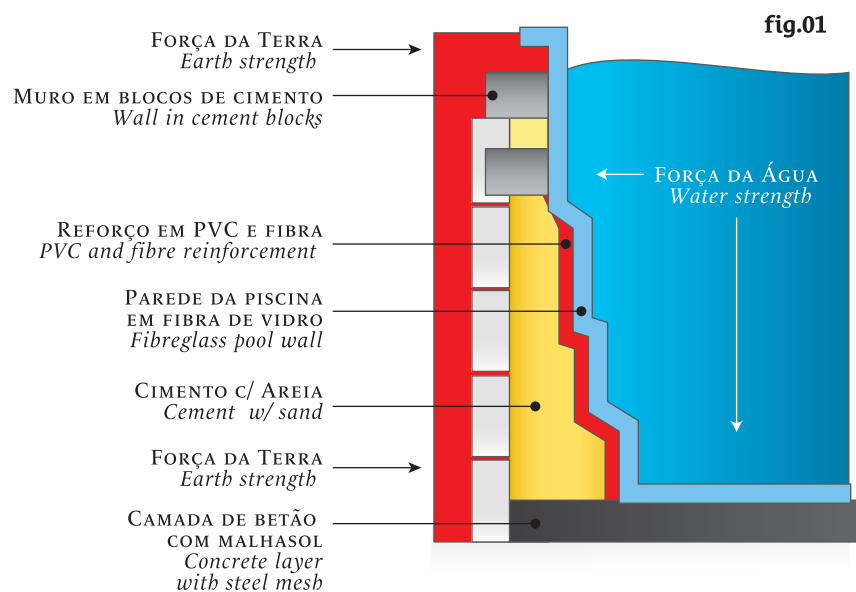

Na situação de piscinas com linhas retas com dimensões superiores aos 9,80mts (figura 1), são instaladas com uma parede de contenção em blocos de cimento para criar o equilíbrio perfeito das forças exercidas quer pela pressão e peso da água, quer pela pressão da terra.

*Pools with straight lines and dimensions exceeding 9.80 m (figure 1) are installed with a cement block retaining wall to create the perfect balance of the forces exerted by the pressure and weight of the water and by the pressure of the earth.*

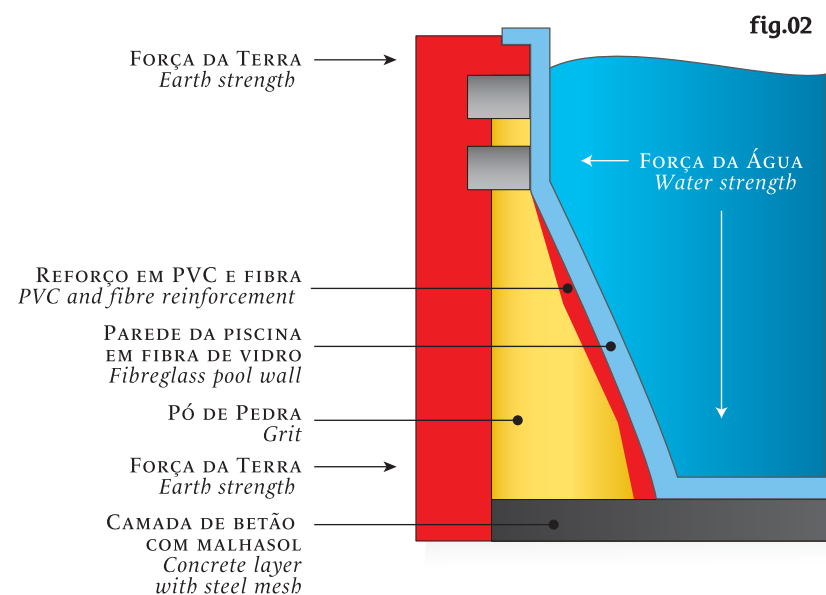

Na situação das piscinas com linhas curvas e linhas retas com dimensões inferiores a 9,80mts (figura 2), não existe a necessidade da parede de contenção, pois a própria forma da piscina e a estruturação dos seus reforços torna-a autoportante, sendo essa parede substituída por uma camada de pó de pedra.

*For pools with curved and straight lines with dimensions under 9.80 metres (figure 2), there is no need for the retaining wall, as the reinforced shape and structure of the pool makes it self-supporting and the wall is replaced by a layer of grit.*



Estrada Nacional 109, km 160  
Barruinhos  
2425-737 Ortigosa (Leiria)

Tel.: **244 619 930**  
Fax: **244 619 939**

[www.fapicentro.pt](http://www.fapicentro.pt)  
[info@fapicentro.pt](mailto:info@fapicentro.pt)  
[comercial@fapicentro.pt](mailto:comercial@fapicentro.pt)

Postos de Venda:  
*Sales Offices:*

> **Batalha**

E.N. 1, S. Jorge  
2480-062 Calvaria de Cima  
Tel.: **244 619 930**  
Tel.: **244 481 948**

> **Albufeira**

E.N. 125, Cortelhas  
(em frente ao Zoomarine)  
(in front of Zoomarine)  
8200-413 Guia ABF  
Tel.: **289 562 579**  
Tlm.: / Mobile.: +351 **918 740 596**

> **Anadia**

Curia  
3780-541 Tamengos  
Tlm.: / Mobile.: +351 **912 589 929**

